



# UG95 UMTS/HSPA Module Presentation

August, 2014

# Contents

**Highlights**

**Advanced Features**

**UG95 Vs. Competitor's Products**

**Support Package**



# Highlights

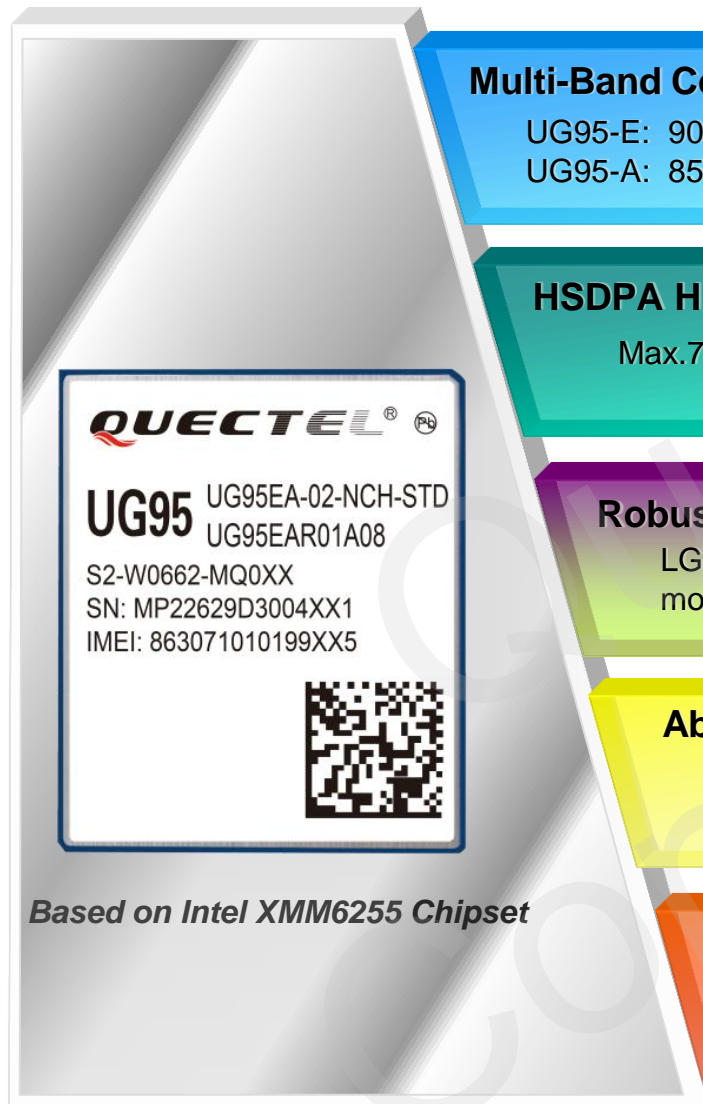

*Based on Intel XMM6255 Chipset*

*\* Under development*

## Multi-Band Combination

UG95-E: 900/2100MHz @UMTS, 900/1800MHz @GSM  
UG95-A: 850/1900MHz @UMTS, 3G only

## HSDPA High Speed Packet Access

Max.7.2 Mbps (DL), Max.5.76 Mbps (UL)

## Robust Package

LGA package with heat sink design, compatible with GSM/GPRS M95 module in unified form factor

## Abundant Functionalities and Interfaces

USB/UART/USIM/Digital Audio through PCM(optional)/RESET/  
NETLIGHT/STATUS/I2C/eCall\*

## Extended Temperature Range

-35°C ~ +70°C

# Mechanical Dimensions



Length: 19.9 mm ( $\pm 0.15$ mm)  
Width: 23.6 mm ( $\pm 0.15$ mm)  
Height: 2.2 mm ( $\pm 0.2$ mm)  
Weight: Approx. 2.5g

# Hardware Architecture

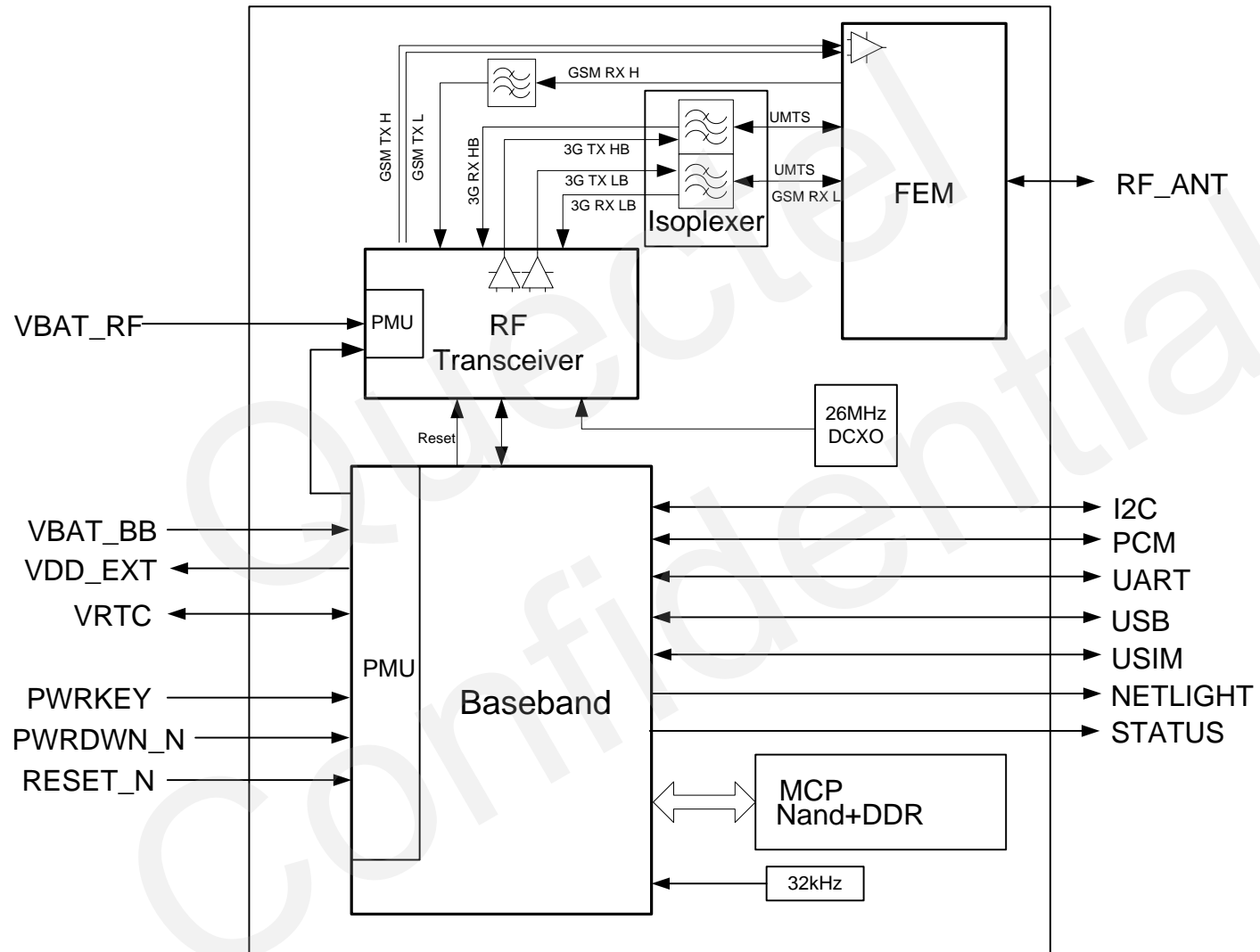

# Software Advantages

## USB Serial Drivers

- Windows XP/ Vista/ 7/ 8/  
Windows Mobile 6.1\*/6.5\*
- Windows CE5.0\*/6.0\*
- Linux 2.6 or later
- Android 2.3 or later

## Quality Guarantee

- Reliable network protocol
- Steady flash protected mechanism
- Superior audio algorithms
- High sensitivity

## Mux&RIL Drivers

- RIL: Android 2.3/4.0/4.2 ,  
Windows CE6.0\* ,  
Windows Mobile 6.1\*/6.5\*
- MUX: Linux 2.6\* or later  
Android 2.3\* or later

## Flexible Applications

- eCall\*

## Abundant Protocols

- TCP/IP, UDP, PPP
- SMS
- FTP\*, HTTP\*, HTTPS\*, MMS\*,  
SMTP\*, SMTPS\*, PING\*, NTP\*
- SSL\*

## Special Features

- QuecFOTA\*
- QuecFile\*
- SIM Detection
- QuecLocator\*
- Over Temp.&Voltage Protection\*

\* Under development

# Enhanced AT Commands

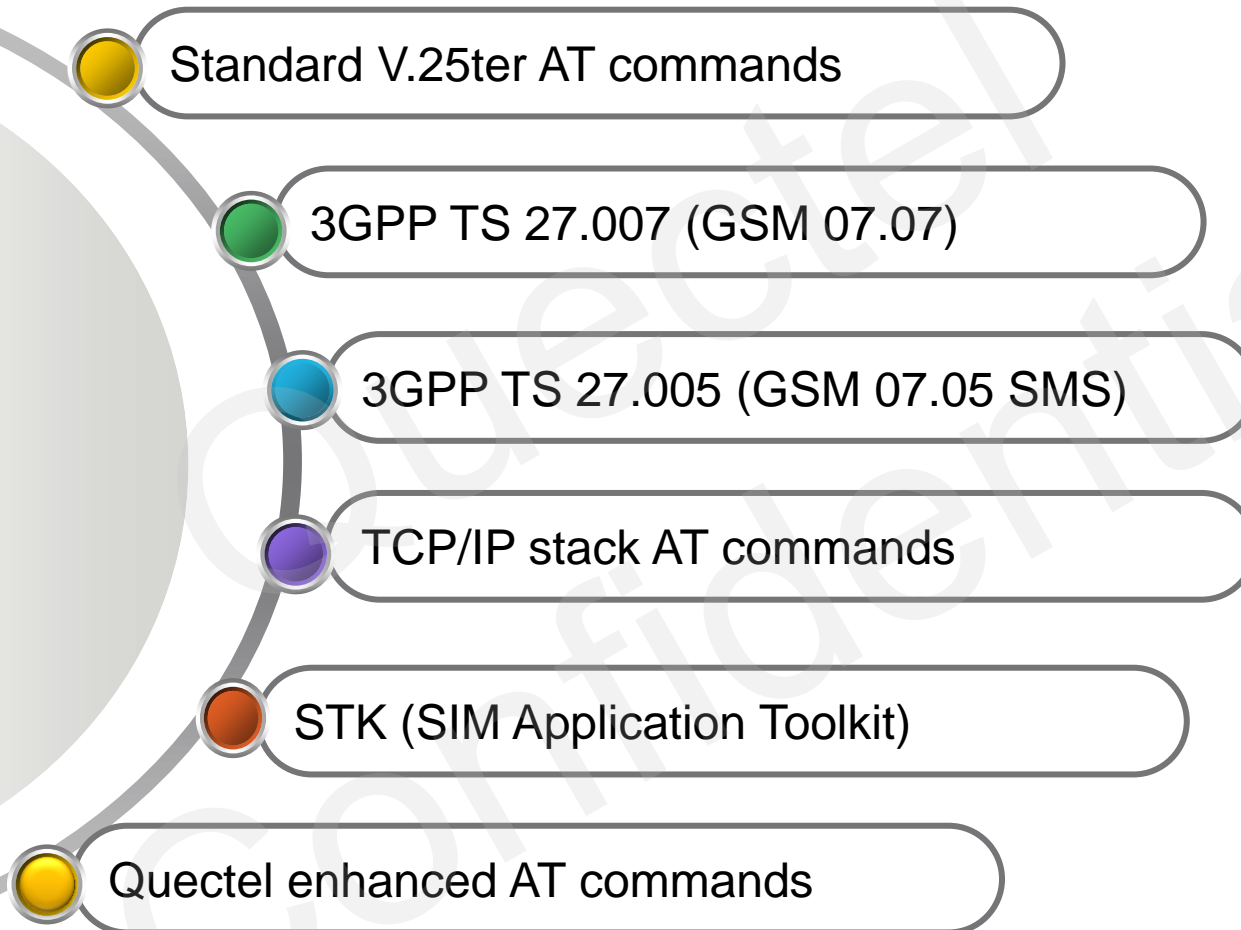

# Target Applications





# Contents

Highlights

Advanced Features

UG95 Vs. Competitor's Products

Support Package



UG95 supports eCall function.



A car will have an electronic safety system automatically calling emergency services in case of a serious accident. Even if the driver is unconscious, the system will inform rescue workers of the crash site's exact whereabouts, and the rescues will be on its way within minutes. **The system is named as "eCall".**

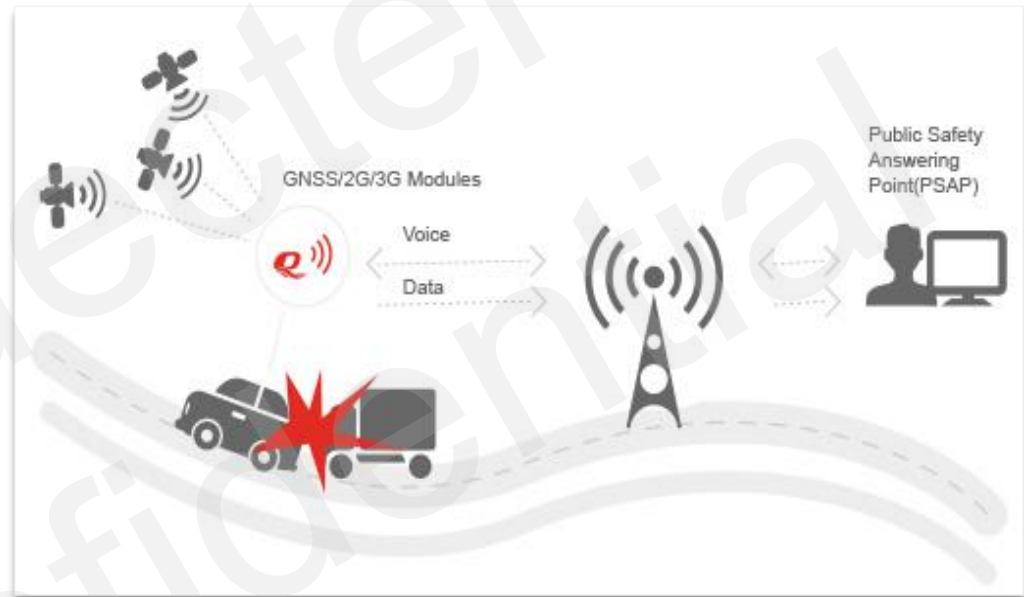

*Quectel supports eCall in 2G Modules as well and has been working on eCall since late 2011. Quectel has enough development experience on eCall to support and assist with customer's eCall application development.*

*\* Under development*

# QuecLocator \*

## QuecLocator, Quectel Cell Locate Technology

Since Quectel modules have its own cloud server, customers can be free to get cell location information through Internet.

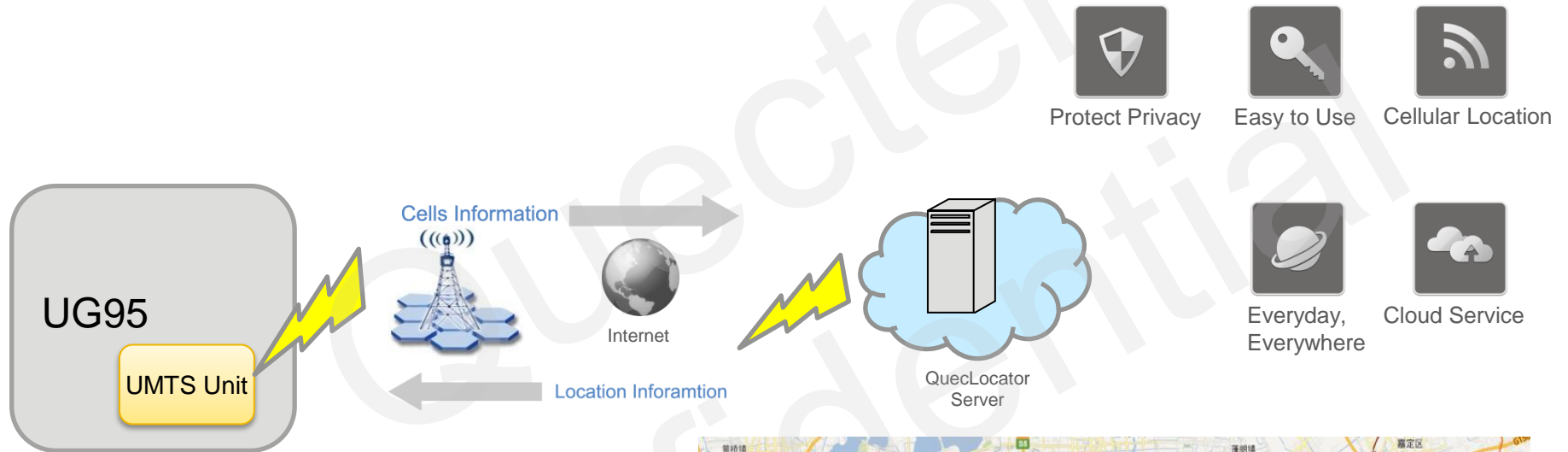

### Field Test Result



GPS signal records



UMTS signal records

\* Under development

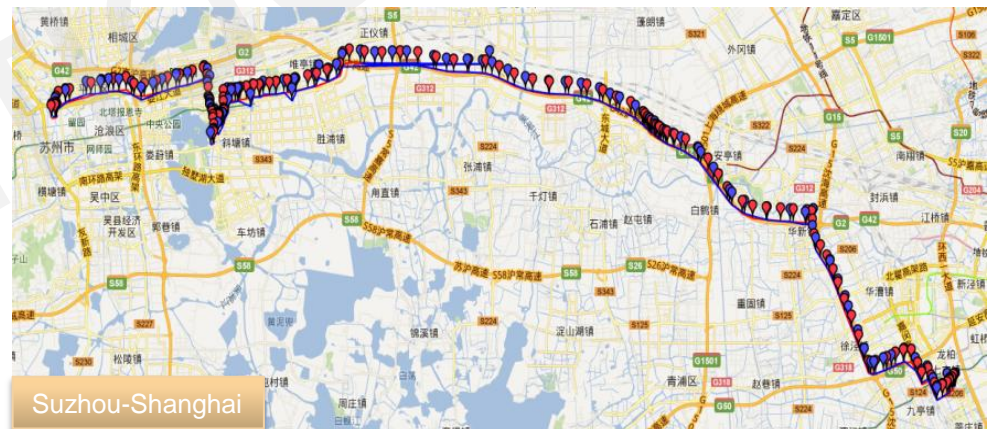

# QuecFOTA \*

FOTA is an acronym for Firmware Over-the-Air. QuecFOTA updating technology enables mobile device manufacturers to remotely update software. New software can be delivered over the air, eliminating the need for the user to bring the device to a service facility.

## QuecFOTA Upgrade Process

- QuecFOTA Sync
- QuecFOTA Packet
- QuecFOTA Upgrade Error Handle

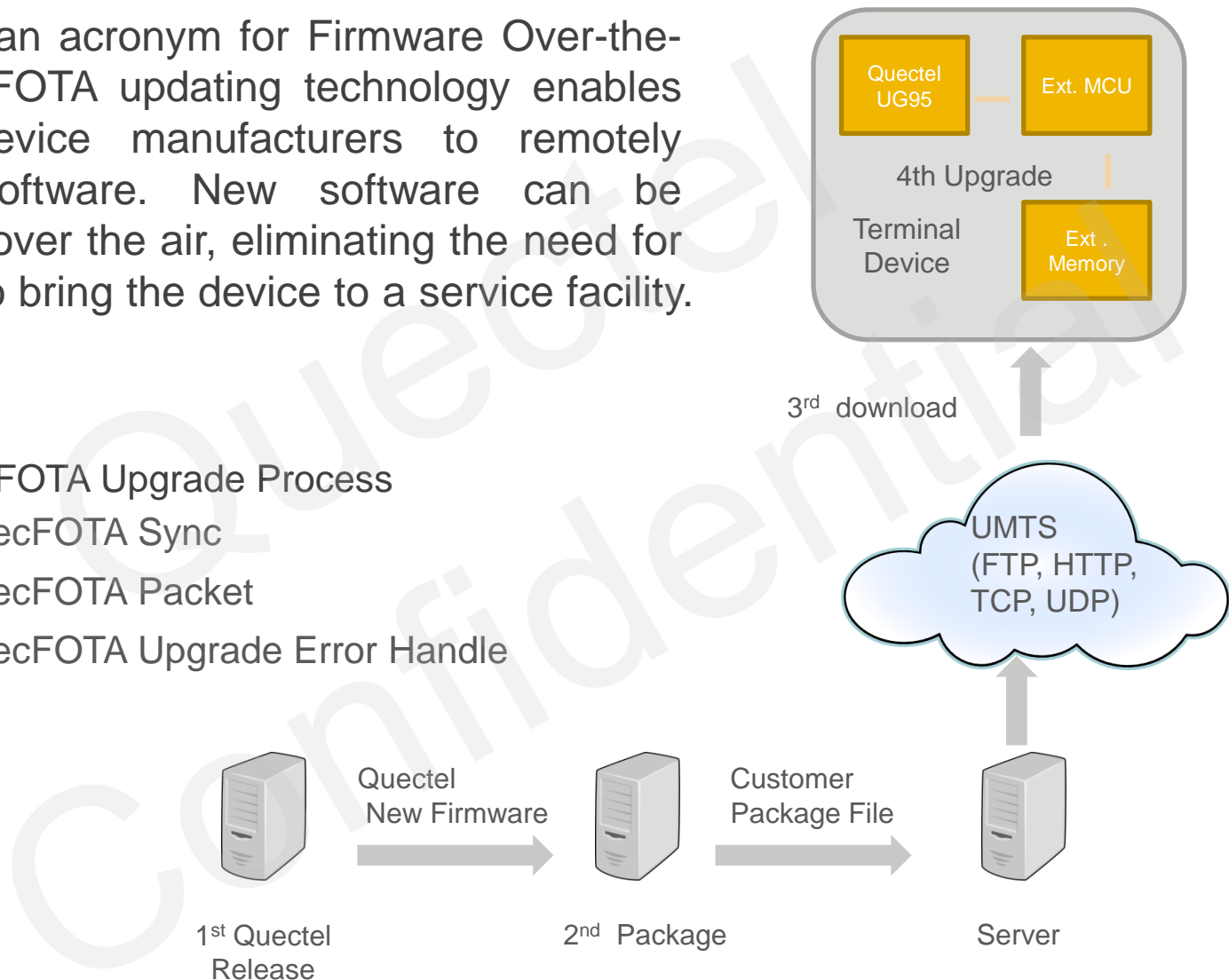

\* Under development

# Analog Audio Solution

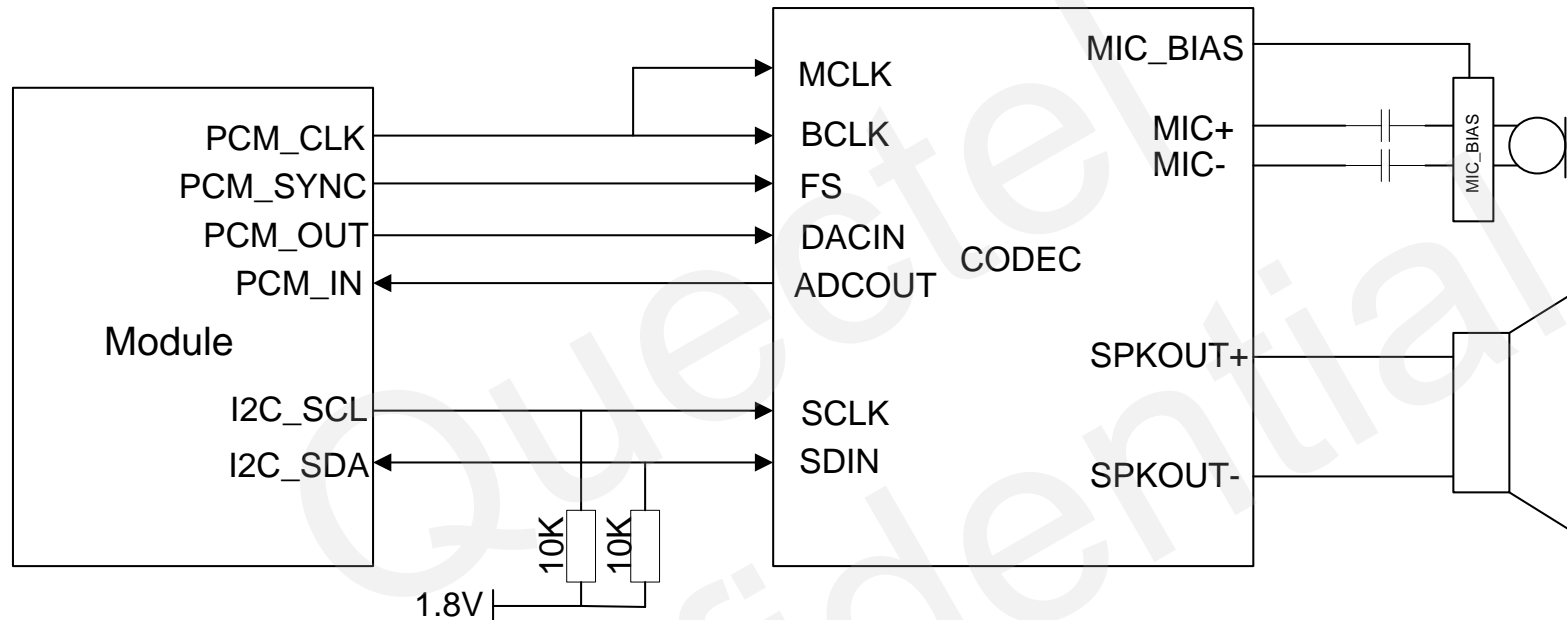

UG95 can implement the analog audio function through a total recommended solution as shown in the above figure. This external circuit allows UG95 module to deliver exceptional audio performance, which is fully verified by Quectel.

# Layout Compatibility

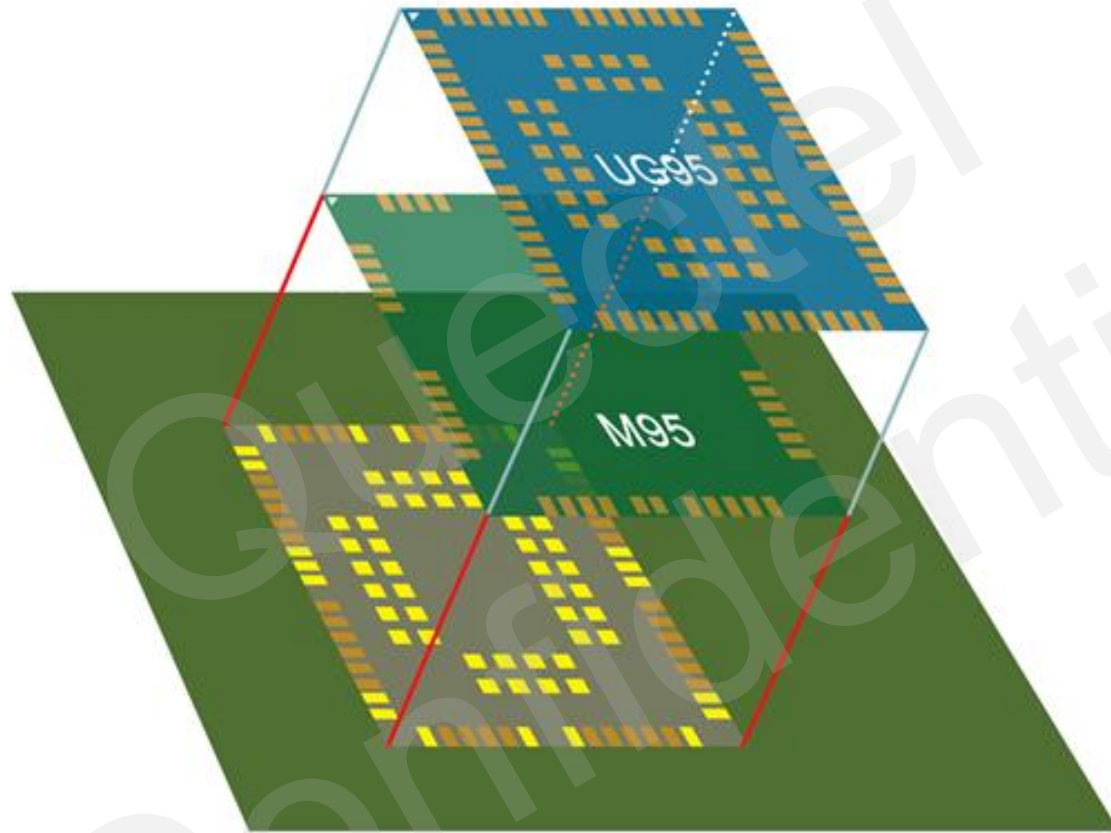

UG95 is compatible with GSM/GPRS M95 module. Compatibility design accommodates both M95 and UG95 modules on the same PCB footprint.

# Contents

Highlights

Advanced Features

**UG95 Vs. Competitor's Products**

Support Package



# UG95 Vs. Competitors' Products

Feature	UG95	UX865-N3G	SXRA-U2X	EXS5	HX8548
Platform	XMM6255	XMM6255	XMM6255	XMM6250	XMM6250
Package	LGA	LCC	LGA	LGA	LGA
Dimension	19.9×23.6×2.2 mm	24.4×24.4×2.6 mm	16×26×3 mm	27.6×18.8×2.3 mm	22×23×2.5 mm
Supply Voltage	3.4 to 4.3 V	3.4 to 4.2V	3.3 to 4.4V	3.3 to 4.5V	Unknown
Data Rate	DL 7.2 Mbps UL 5.76 Mbps	DL 7.2 Mbps UL 5.76 Mbps	DL 7.2 Mbps UL 5.76 Mbps	DL 7.2 Mbps UL 5.76 Mbps	Unknown
Voice	Supported (digital )	Supported (digital )	Supported (digital )	Supported (digital)	Supported ( digital)
eCall *	Supported	Not supported	Optional	Not supported	Not supported
Over Temp&Voltage Protection*	Supported	Not supported	Unknown	Not supported	Unknown
Compatibility with 2G Module	With M95	With XL865	With SXRA-G3	With BGS2	With HX6528
Quec Enhanced Function	QuecFile* QuecFOTA* ...				

\* Under development



# Contents

Highlights

Advanced Features

UG95 Vs. Competitor's Products

Support Package



# Technical Materials Package

## ➤ Technical materials package

- Hardware, software, specification
- Application note package
- Debug tool, download tool, test tool, EVB package, USB drivers.
- Approvals & test report package



## ➤ Development tool

- Interfaces
  - ✓ RS-232 interfaces
  - ✓ USB interface
  - ✓ Power supply
  - ✓ Antenna interface
  - ✓ Handset interface
  - ✓ Earphone interface
  - ✓ Test interface
- Features
  - ✓ Digital or analog audio interface
  - ✓ Network status LED
  - ✓ Power key
  - ✓ Reset key

**Thank you**

